

METAL MAN[®]

MP251ILCD

OWNER'S MANUAL



7/2022



WARNING:

Read carefully and understand all **ASSEMBLY AND OPERATION INSTRUCTIONS** before operating. Failure to follow the safety rules and other basic safety precautions may result in serious personal injury.

WARRANTY

METAL MAN WORK GEAR CO

EFFECTIVE JANUARY 1, 2013

LIMITED WARRANTY

This warranty applies to the original purchaser and is subject to the terms and conditions listed below. This Limited Warranty is for new equipment sold after the above date, providing coverage for defects in material and workmanship at the time it is shipped from the factory.

Limited to the warranty periods below, Metal Man Work Gear Co will repair or replace the item under warranty that fails due to defects in material and workmanship. Metal Man Work Gear must be notified within 30 days of the failure, to provide instructions on how to proceed with the repair of your welder and warranty claim processing. Warranty period begins at the time the welder is purchased from and Authorized Reseller of Metal Man Work Gear Co. products. **Keep your receipt as proof of purchase.**

Warranty Periods

Limited Warranty is divided into three categories. No Warranty, 90 days and 3 year.

No Warranty

Normal wear items, MIG gun parts (contact tips, nozzle, contact tip adapter, MIG gun liner), drive roll, electrode holder, ground clamps, Plasma torch parts (nozzle, electrode, diffuser, cover) are considered consumable items and are not covered under warranty.

90 days

Parts for Metal Man Work Gear welding carts and welding cabinets. This warranty covers the absence of or defective parts.

3 year

This 3 year warranty covers parts and Labor on items such as: transformer, reactor, rectifier, solenoid valve, PC Board, switches, controls, gas valve, drive motor, drive system other than drive roll and any other component that requires the removal of the sheet metal to access. Any shipping related to warranty repair is the responsibility of the customer.

Voiding Warranty

Warranty does not apply to: Shipping Damage, Misuse and abuse of the unit, alteration of the unit in any way.

Warranty Claim

This is a parts and labor warranty. **Do not return your unit to the retailer you purchased it from.** Retain your receipt in the case a warranty claim is needed. No warranty will be provided without the original receipt from an authorized reseller of Metal Man Work Gear Products. To make a warranty claim, call our welder help line at 888-762-4045, M-F 8:00 am to 5:00 PM Central time or email sales@metalmangear.com.

GENERAL SAFETY RULES



WARNING: Read and understand all instructions. Failure to follow all instructions listed below may result in serious injury.



CAUTION: Do not allow persons to operate or assemble this MMP251ILCD until they have read this manual and have developed a thorough understanding of how the MIG/Stick 220Si works.



WARNING: The warnings, cautions, and instructions discussed in this instruction manual cannot cover all possible conditions or situations that could occur. It must be understood by the operator that common sense and caution are factors which cannot be built into this product but must be supplied by the operator.

WARNING

Breathing welding fumes exposes you to chemicals, including chromium (hexavalent compounds), known to the State of California to cause cancer and birth defects or other reproductive harm.

*Always weld in a well-ventilated area. * If in an enclosed area, vent the exhaust to the outside. For more information go to www.P65warnings.ca.gov

WARNING

This product can expose you to chemicals including Lead, which is known to the State of California to cause cancer and birth defects or other reproductive harm. For more information go to www.P65warnings.ca.gov

SAVE THESE INSTRUCTIONS

IMPORTANT SAFETY CONSIDERATIONS

1.1 Your Welding Environment

- Keep the environment you will be welding in free from flammable materials.
- Always keep a fire extinguisher accessible to your welding environment.
- Always have a qualified person install and operate this equipment.
- Make sure the area is clean, dry and ventilated. Do not operate the welder in humid, wet or poorly ventilated areas.
- Always have your welder maintained by a qualified technician in accordance with local, state and national codes.
- Always be aware of your work environment. Be sure to keep other people, especially children, away from you while welding.
- Keep harmful arc rays shielded from the view of others.
- Mount the welder on a secure bench or cart that will keep the welder secure and prevent it from tipping over or falling.

1.2 Your Welder's Condition

- Check ground cable, power cord and welding cable to be sure the insulation is not damaged. Always replace or repair damaged components before using the welder.
- Check all components to ensure they are clean and in good operating condition before use.

1.3 Use of Your Welder

▲ CAUTION

Do not operate the welder if the output cable, electrode, torch, wire or wire feed system is wet. Do not immerse them in water. These components and the welder must be completely dry before attempting to use them.

- Follow the instructions in this manual.
- Keep welder in the off position when not in use.
- Connect ground lead as close to the area being welded as possible to ensure a good ground.
- Do not allow any body part to come in contact with the welding wire if you are in contact with the material being welded, ground or electrode from another welder.
- Do not weld if you are in an awkward position. Always have a secure stance while welding to prevent accidents. Wear a safety harness if working above ground.
- Do not drape cables over or around your body.
- Wear a full coverage helmet with appropriate shade (see ANSI Z87.1 safety standard) and safety glasses while welding.
- Wear proper gloves and protective clothing to prevent your skin from being exposed to hot metals, UV and IR rays.
- Do not overuse or overheat your welder. Allow proper cooling time between duty cycles.
- Keep hands and fingers away from moving parts and stay away from the drive rolls.
- Do not point torch at any body part of yourself or anyone else.
- Always use this welder in the rated duty cycle to prevent excessive heat and failure.

1.4 Specific Areas of Danger, Caution or Warning



Electrical Shock

▲ WARNING

Electric arc welders can produce a shock that can cause injury or death. Touching electrically live parts can cause fatal shocks and severe burns. While welding, all metal components connected to the wire are electrically hot. Poor ground connections are a hazard, so secure the ground lead before welding.

- Wear dry protective apparel: coat, shirt, gloves and insulated footwear.
- Insulate yourself from the work piece. Avoid contacting the work piece or ground.
- Do not attempt to repair or maintain the welder while the power is on.
- Inspect all cables and cords for any exposed wire and replace immediately if found.
- Use only recommended replacement cables and cords.
- Always attach ground clamp to the work piece or worktable as close to the weld area as possible.
- Do not touch the welding wire and the ground or grounded work piece at the same time.
- Do not use a welder to thaw frozen pipes.



Fumes and Gases

▲ WARNING

- Fumes emitted from the welding process displace clean air and can result in injury or death.
- Do not breathe in fumes emitted by the welding process. Make sure your breathing air is clean and safe.
- Work only in a well-ventilated area or use a ventilation device to remove welding fumes from the environment where you will be working.

-Do not weld on coated materials (galvanized, cadmium plated or containing zinc, mercury or barium). They will emit harmful fumes that are dangerous to breathe. If necessary, use a ventilator, respirator with air supply or remove the coating from the material in the weld area.

-The fumes emitted from some metals when heated are extremely toxic. Refer to the material safety data sheet for the manufacturer's instructions.

-Do not weld near materials that will emit toxic fumes when heated. Vapors from cleaners, sprays and degreasers can be highly toxic when heated.



UV and IR Arc Rays

▲ DANGER

The welding arc produces ultraviolet (UV) and infrared (IR) rays that can cause injury to your eyes and skin. Do not look at the welding arc without proper eye protection.

-Always use a helmet that covers your full face from the neck to top of head and to the back of each ear.

-Use a lens that meets ANSI standards and safety glasses. For welders under 160 Amps output, use a shade 10 lens; for above 160 Amps, use a shade 12. Refer to the ANSI standard Z87.1 for more information.

-Cover all bare skin areas exposed to the arc with protective clothing and shoes. Flame-retardant cloth or leather shirts, coats, pants or coveralls are available for protection.

-Use screens or other barriers to protect other people from the arc rays emitted from your welding.

-Warn people in your welding area when you are going to strike an arc so they can protect themselves.



Fire Hazards

▲ WARNING

Do not weld on containers or pipes that contain or have had flammable, gaseous or liquid combustibles in them. Welding creates sparks and heat that can ignite flammable and explosive materials.

-Do not operate any electric arc welder in areas where flammable or explosive materials are present.

-Remove all flammable materials within 35 feet of the welding arc. If removal is not possible, tightly cover them with fireproof covers.

-Take precautions to ensure that flying sparks do not cause fires or explosions in hidden areas, cracks or areas you cannot see.

-Keep a fire extinguisher close in the case of fire.

-Wear garments that are oil-free with no pockets or cuffs that will collect sparks.

-Do not have on your person any items that are combustible, such as lighters or matches.

-Keep work lead connected as close to the weld area as possible to prevent any unknown, unintended paths of electrical current from causing electrical shock and fire hazards.

-To prevent any unintended arcs, cut wire back to ¼" stick out after welding.



Hot Materials

▲ CAUTION

Welded materials are hot and can cause severe burns if handled improperly.

-Do not touch welded materials with bare hands.

-Do not touch torch nozzle after welding until it has had time to cool down.

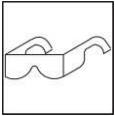

Sparks/Flying Debris

▲ CAUTION

Welding creates hot sparks that can cause injury. Chipping slag off welds creates flying debris.

-Always wear protective apparel: ANSI-approved safety glasses or shield, welder's hat and ear plugs to keep sparks out of ears and hair.



Electromagnetic Field

▲ CAUTION

-Electromagnetic fields can interfere with various electrical and electronic devices such as pacemakers.

-Consult your doctor before using any electric arc welder or cutting device

-Keep people with pacemakers away from your welding area when welding.

-Do not wrap cable around your body while welding.

-Wrap MIG gun and ground cable together whenever possible.

-Keep MIG gun and ground cables on the same side of your body.

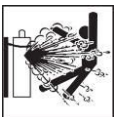

Shielding Gas Cylinders Can Explode

▲ WARNING

High pressure cylinders can explode if damaged, so treat them carefully.

-Never expose cylinders to high heat, sparks, open flames, mechanical shocks or arcs.

-Do not touch cylinder with MIG gun.

-Do not weld on the cylinder

-Always secure cylinder upright to a cart or stationary object.

-Keep cylinders away from welding or electrical circuits.

-Use the proper regulators, gas hose and fittings for the specific application.

-Do not look into the valve when opening it.

-Use protective cylinder cap whenever possible

1.5 Proper Care, Maintenance and Repair

▲ DANGER

-Always have power disconnected when working on internal components.

- Do not touch or handle PC board without being properly grounded with a wrist strap. Put PC board in static proof bag to move or ship.

-Do not put hands or fingers near moving parts such as drive rolls of fan

MMP251ILCD USE AND CARE

- **Do not modify this unit in any way.** Unauthorized modification may impair the function and/or safety and could affect the life of the equipment. There are specific applications for which this unit was designed.
- **Always check of damaged or worn out parts before using this unit.** Broken parts will affect the operation. Replace or repair damaged or worn parts immediately.
- **Store idle.** When this unit is not in use, store it in a secure place out of the reach of children. Inspect it for good working condition prior to storage and before re-use.

TECHNICAL SPECIFICATIONS

Property	Specification
Power Supply	230V, 45A, 50/60 Hz, Single Phase
No-Load Voltage	69V DC
Output Range – MIG/FLUX Core	40 to 250A DC
Output Range - STICK	20 to 200A DC
Output Range - TIG	15 to 250A DC
Duty Cycle - MIG	20% @ 250A
Duty Cycle – Stick	20% @ 200A
Duty Cycle – TIG	20% @ 250A
Suggested Wire	Steel, Stainless Steel, Aluminum
Suggested Wire Diameter	.023, .030; .035, .045
Suggested Electrodes	E6013, E7014, E7018, Stainless Steel
Electrode Diameter	1/16 inch to 5/32 inch
Dimensions	38.66 inch x 20.87 inch x 32.68 inch
Weight	115 lb.

DESCRIPTION

The Metal Man MMP251ILCD is an inverter-powered, wire feed welder for flux core and MIG welding plus a DC stick welder. It features a Synergic LCD control that allows the operator to select process and weld settings. It comes complete with two regulators and gas hoses for easy connection for MIG welding plus with optional purchase a weld cable and electrode holder for DC stick welding. Directly connect this unit to a 230V NEMA 6-50R receptacle. It is designed to weld materials as thin as 24 gauge all the way up to 1/2" in a single pass. The optional Spool Gun (**EZFSG2**) is capable of welding aluminum with 4" spools of aluminum wire. This unit can also perform lift start DC TIG welding on steel and stainless-steel materials with included TIG Torch (**ACTT2V**). Argon shielding gas and a TIG filler rod would also be required for TIG welding.

This unit is intended to be used on a 50-amp 230V AC circuit, without the use of an extension cord. If an extension cord is necessary for your application, use the appropriate size and length of extension cord that will handle 50 amps the entire length of the extension. We highly recommend talking with a qualified electrician for cord size recommendations. This unit is supplied with a NEMA Class 6-50P plug and will require a NEMA Class 6-50R receptacle. **Do not remove the power plug.**

Inverter-based welding provides a smoother arc, increases efficiency, and provides better control than non-inverter welding machines.



MIG TORCH

The welding wire is driven through the welding cable and torch to the work piece. It is attached to the drive system. The trigger activates the drive motor.

POWER CORD AND PLUG

Plug this unit into a 230V, 50-amp circuit breaker power supply when operating on 230V.

INERT GAS REGULATOR'S AND GAS HOSE

The Inert Gas Regulator installs on the shielding gas cylinder for MIG welding with solid wires. The regulator controls the compressed gas and allows you to adjust the flow rate of the gas. The gas hose connects to the regulator/flow gauge and delivers the shielding gas from the shielding gas bottle to the welder.

MULTI-FUNCTION ADJUSTMENT/SELECTOR KNOB

The Multi-Function Adjustment/Selector Knob is used by the operator to interact with the LCD Synergic Control. It is used to make selections and adjustments of welding processes, materials, and selections within the LCD Synergic Control screen.

LCD SYNERGIC CONTROL

The LCD Synergic Control sets and operates the welder based on selections the operator makes in weld process and material selections.

WELDING VOLTAGE CONTROL

The voltage control allows the operator to make manual voltage adjustments to the LCD Synergic programming.

GROUND CABLE AND CLAMP

The ground cable and clamp are attached to the work piece to complete the circuit allowing the flow of current needed to weld.

INSTALLATION

1. POWER REQUIREMENT - AC single phase 230V (200-240V) 60 HZ fused with a 50-amp time delayed fuse or circuit breaker is required. DO NOT OPERATE THIS UNIT if the ACTUAL power source voltage is less than 215 volts AC or greater than 240 volts AC.

Electrical Shock

▲ WARNING

- **High voltage danger from power source! Consult a qualified electrician for proper installation of receptacle. This welder must be grounded while in use to protect the operator from electrical shock.**
- **Do not remove grounding prong or alter the plug in any way. Do not use any adapters between the welder's power cord and the power source receptacle. Make sure the POWER switch is OFF when connecting your welder's power cord to a properly grounded 230 VAC, 60 HZ, Single Phase, 50 Amp input power supply.**

2. EXTENSION CORD - We do not recommend an extension cord because of the voltage drop they produce. This drop in voltage can affect the performance of the welder. If you need to use an extension cord, it must be size #12 or larger. Check with a qualified electrician and your local electrical codes for your specific area. Do not use an extension cord over 25 ft. in length.

3. INSTALL THE WIRE ROLLER - The wire roller has been factory installed. However, check to make certain the correct wire groove is in place to accommodate the size of wire you are using. Open the wire feed compartment. Adjust the drive roller according to the following steps, see following picture about the wire feeder structure:

3.1 Open the door to the welder drive compartment.

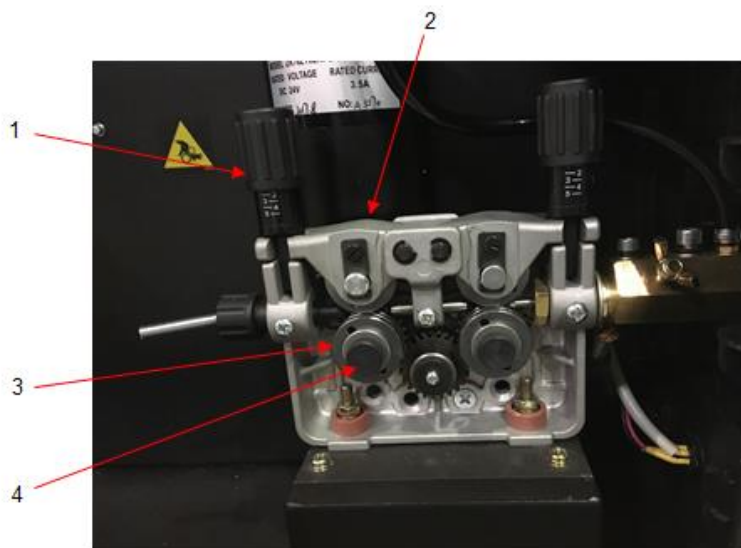

Figure 2

3.2 Remove the drive tension by loosening the Drive Tension Adjuster (1) and moving the Drive Tension Adjuster away from the Drive Tension Arm (2). Lift the Drive Tension Arm away from the Drive Roller (3).

3.3 If there is wire already installed in the welder, roll it back onto the wire spool by hand-turning the spool clockwise. Be careful not to allow the wire to come out of the rear end of the inlet guide tube without holding onto it or the wire spool will unspool itself. Put the end of the wire into the hole on the outside edge of the wire spool and bend it over to hold the wire in place. Remove the spool of wire from the drive compartment of the welder.

3.4 Remove the drive roller by turning the drive roll securement knob (4) counterclockwise. Carefully slide the drive roll assembly off the drive shaft. This drive roll assembly consists of three pieces, the outer drive roll, inner drive roll, and a key. Be careful not to misplace the key.

3.5 Based on the wire diameter select the correct groove. See the chart below for assistance. When installing the drive roller, the number stamped on the drive roller for the wire size you are using should be facing inward. Push the Drive Roller onto the Drive Roller Shaft.

3.6 Reinstall the Drive Roller knob and tighten clockwise.

3.7 Close the door to the welder drive compartment.

4. INSTALL THE WIRE - We recommend the usage of .023, .030, and .035 MIG wire, or .030, .035 and .040 flux core wire, on this unit.

4.1 Select welding wire - Both 8" and 11" wire spools of .023, .030, .035 and .040 wire can be used on this welder. You can also use 4" spools of wire when using the Spool Gun EZFSG2.

NOTE: - Burn through can occur if you attempt to weld mild or stainless steel thinner than 24 gauge.

- Remove all rusted wire from your wire spool. If the whole spool is rusty, discard it.

4.2 Installing the wire

Electrical Shock

▲ WARNING

- **Electric shock can kill! Always turn the POWER switch OFF and unplug the power cord from the AC power source before installing wire.**

NOTE:

- Before installing, make sure that you have removed any old wire from the torch assembly. This will help to prevent the possibility of the wire jamming inside the gun liner.

- Be very careful when removing the welding nozzle. The contact tip on this welder is live whenever the torch trigger is pulled. Make certain POWER is turned OFF.

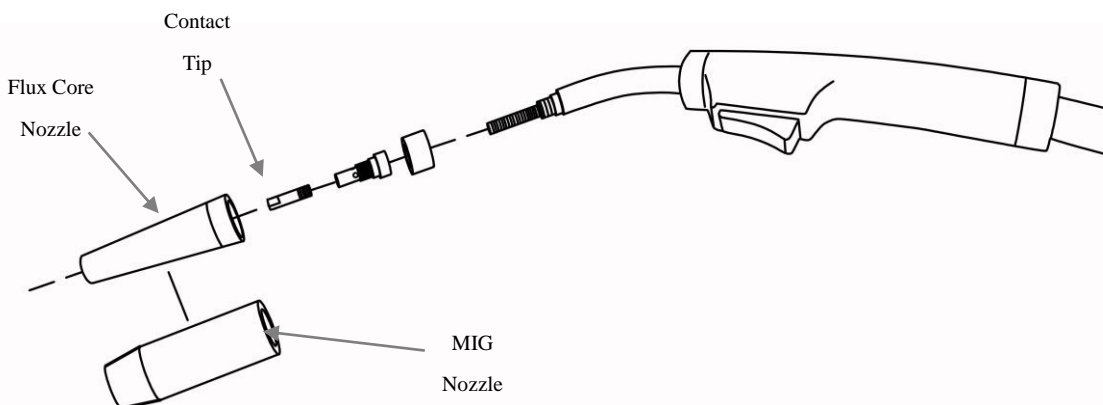

4.2.1 Remove the nozzle and contact tip from the end of the torch assembly.

4.2.2 Make sure the proper groove on the drive roller is in place for the wire installed. If not, change the drive roller as described in Section 3.

4.2.3 Remove the packaging from the spool of wire and then identify the leading end of the wire secured on the edge of the spool. **DO NOT UNHOOK IT AT THIS TIME.**

4.2.4 Place the spool on the spool hub so the wire will pull off the bottom of the spool.

The welding wire should always come off the bottom of the spool into the drive mechanism. See following figure.

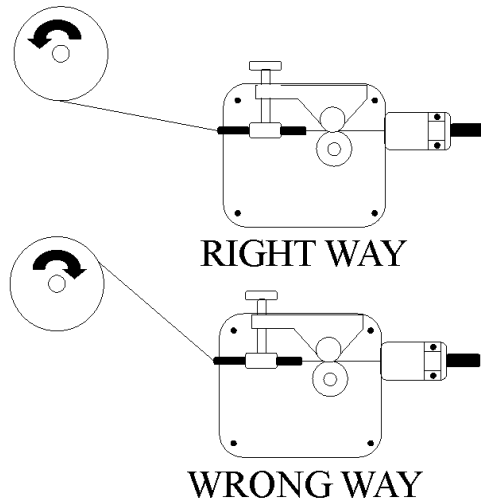

4.2.5 The welder can use either 8 inch or 11-inch spools. The wire spool retainer secures the spool of wire onto the spool hub. The Wire Spool Tension Set Screw controls the tension on the spool.



4.2.6 Setting the wire spool tension. a) Turn the spool of wire with one hand. b) Increase the spool tension by tightening (turn clockwise) the Wire Spool Tension Set Screw while turning the spool. Turn the spool while tightening the Wire Spool Tension Set Screw until the spool slows down and you feel a slight drag. Stop tightening the Wire Spool Tension Set Screw, you may need to repeat these steps until proper spool tension is achieved.

NOTE: If TOO MUCH tension is applied to the wire spool, the wire will slip on the drive roller or will not be able to feed at all. If TOO LITTLE tension is applied, the spool of wire will want to unspool itself when the trigger is released. Readjust the spool tension using the wing nut as necessary to correct for either problem.

4.2.7 With the welder disconnected from the power source, remove the leading end of the wire from the spool. **Hold on to it securely**, so as not to allow unspooling or tangling of the wire as it will result in tangled wire and feeding problems.

4.2.8 Cut off any bent portion of the wire using a wire cutter.

4.2.9 Loosen the tension adjusting knob holding the drive tension arm in place and lift the tension arm up off the drive roller.

4.2.10 Insert the wire into the inlet guide tube, feed it across the drive roller and into the torch assembly about six inches.

▲ CAUTION

-Make certain that the welding wire is actually going into the torch liner. If not, the wire will jam up in the mechanism.

4.2.11 Line the wire up with the correct groove in the drive roller. Place the drive tension arm back above the drive roller.

4.2.12 Place the drive tension adjustment arm back in place.

4.2.13 Tighten (turn clockwise) the drive tension adjusting knob until the tension roller is applying enough force on the wire to prevent it from slipping in the drive rollers. **DO NOT OVER TIGHTEN.**

4.2.14 **NOW YOU CAN LET GO OF THE WIRE.**

4.2.15 Plug in the welder power cord and turn the welder ON. Set the Voltage switch to the voltage setting recommended for the gauge metal that is to be welded. Refer to the set-up chart on the back side of the drive compartment door.

▲ CAUTION

-The welding wire is electrically hot when the power is on, and the torch trigger is activated.

4.2.16 Set the WIRE SPEED control to the middle of the wire speed range.

4.2.17 Straighten the MIG torch cable and pull the trigger in the gun handle to feed the wire through the torch assembly. When at least one inch of the wire sticks out past the end of the torch, release the trigger.

4.2.18 Turn the Power Switch to the OFF position.

4.2.19 Select a contact tip stamped with the same diameter as the wire being used.

NOTE:

-Due to inherent variances in flux cored welding wire, it may be necessary to use a contact tip one size larger than your flux core wire if wire jams occur.

4.2.20 Slide the contact tip over the wire (protruding from the end of the torch). Thread the contact tip into the end of the torch and hand-tighten securely.

4.2.21 Install the nozzle on the torch assembly.

4.2.22 Cut off excess wire that extends past the end of the nozzle more than 1/4 inch.

4.2.23 Turn the welder ON.

5. SETTING THE DRIVE ROLL TENSION

▲ WARNING

Arc flash can injure eyes! To reduce the risk of arc flash, make certain that the wire coming out of the end of the torch does not come in contact with the work piece, ground clamp, or any grounded material during the drive tension setting process or arcing will occur.

5.1 Press the trigger on the torch.

5.2 Turn the drive tension adjustment knob clockwise until the wire seems to feed smoothly without slipping.

6. GAS INSTALLATION

▲ WARNING

Shielding gas cylinders and high-pressure cylinders can explode if damaged, so treat them carefully.

- **Never expose cylinders to high heat, sparks, open flames, mechanical shocks or arcs.**
- **Do not weld on the cylinder.**
- **Always secure cylinder upright to a cart or stationary object.**
- **Keep cylinders away from welding or electrical circuits.**

- **Use the proper regulators, gas hose and fittings for the specific application.**

6.1 Polarity Changing - When MIG wire is used, shielding gas is required and the polarity on this unit needs to be electrode positive.

6.1.1 Electrode Positive for MIG Welding - The Weld Power Cable should be connected to the positive (+) weld output connection on the front of the machine. The ground cable would then be connected to the negative (-) weld output connection. Refer to the polarity setting label inside the wire compartment.

6.1.2 Electrode Negative for Flux Core Welding - The Weld Power Cable should be connected to the negative (-) weld output connection on the front of the machine. The ground cable would then be connected to the positive (+) weld output connection. Refer to the polarity setting label inside the wire compartment.

6.2 Connect one end of the gas hose to the gas hose connection on the back of the welder. Use a wrench to snug up the connection.

NOTE: There are two separate gas connections on the back of this unit. If connecting the shielding gas for the standard MIG torch, use the gas connection for the MIG torch on the back of the unit. If connecting the shielding gas for the Spool Gun, use the gas connection for the Spool Gun on the back of the unit.

6.3 Connect the other end of the gas hose to the gas hose connection on the supplied regulator/flow gauge. Use a wrench to snug up the connection.

6.4 Before installing the regulator, it is good practice to make certain no debris is in the gas bottle connection. Rotate the bottle so the gas connection is not pointing toward you or any other person. Turn the valve on the gas bottle clockwise and quickly close. This quick thrust of gas will clear any debris in the connection. Connect the regulator to the gas bottle connection. Use a wrench to snug up the connection.

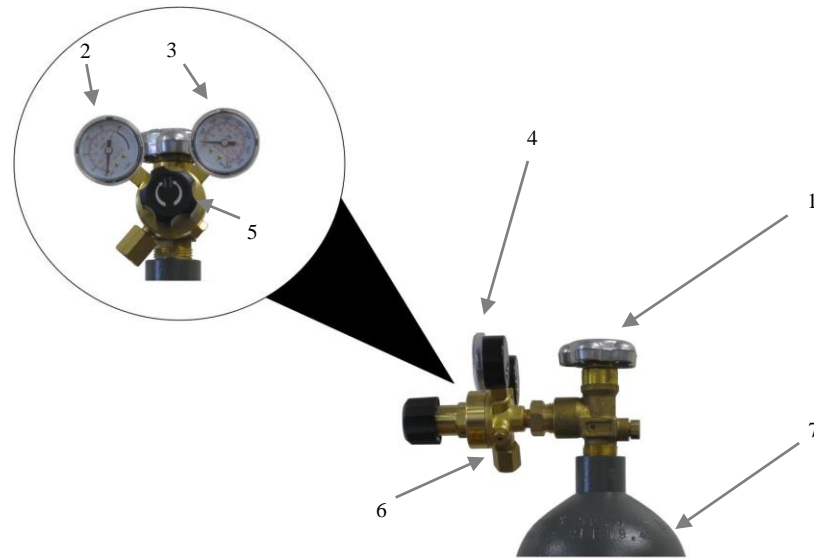

Reference	Subassembly
1	Gas Bottle Valve
2	Gas Flow Gauge (Set at 20 CFH)
3	Gas Pressure Gauge
4	Regulator
5	Gas Flow Adjuster
6	Gas Hose Connection
7	Gas Cylinder

6.5 Open the Gas Bottle Valve on the cylinder of gas.

6.6 Turn the Gas Flow Adjuster on the regulator so that the gas flow rate is set at approximately 20 CFH. Make certain you are reading the correct scale on the gauge.

NOTE: Slowly open the cylinder valve by turning it counterclockwise until the cylinder pressure gauge registers on the first gauge of the regulator. Turn the adjustment knob clockwise (right) slowly to increase gas flow to 20 CFH. To reduce the gas flow, turn the adjustment counterclockwise (left). The gas valve is located on the back panel of the welder and activated by the trigger. Gas flow should be heard when the trigger is activated. No gas flow will result in a harsh arc with excessive spatter, a smooth weld bead will be difficult to obtain. Avoid unnecessary gas loss by closing the tank valve when finished welding.

6.7. Gas selection

Different materials require different shielding gas when MIG welding, refer to the set up chart inside the wire feed compartment.

Mild steel: Use 75% Argon and 25% CO2 for reduced spatter and reduced penetration for thinner materials. Do NOT USE Argon gas concentrations higher than 75% on steel. The result will be extremely poor penetration, porosity, and brittleness of weld.

Mild Steel: Use CO2 for deeper penetration but increased spatter. (A CO2 regulator adapter will be needed)

Stainless steel: Use a mixed gas consisting of Helium, Argon and CO2.

Aluminum or bronze: Use 100% Argon.

ASSEMBLY

1. MIG TORCH ASSEMBLY

- 1.1 Locate the retaining bolt inside the front panel on the drive system. Loosen the retaining bolt.
- 1.2 Make note of the retaining groove on the back end of the MIG torch.

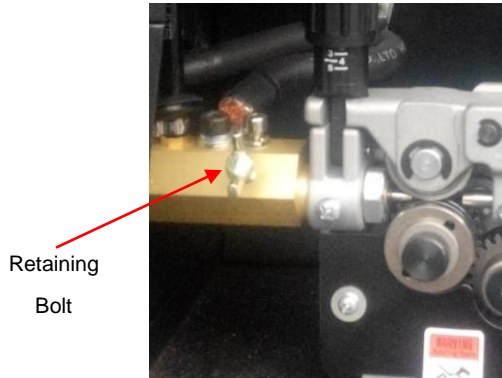

- 1.3 Insert the back end of the MIG torch into the MIG socket on the front of your machine. Make certain to completely slide the torch all the way in. Slightly twist to assist with pushing the torch to the back of the receptacle. The retaining bolt can then be tightened, making certain the bolt sets down into the retaining groove on the back of the MIG torch.
- 1.4 Connect the 5-Pin trigger connection on the MIG torch to the 5-Pin trigger receptacle on the front panel.
- 1.5 Connect the ground cable to the Negative (-) weld output connection for MIG welding. If welding with self-shielded flux core, connect the ground cable to the Positive (+) weld output connection and move the Weld Power Cable to the Negative (-) weld output connection.

2. OPTIONAL SPOOL GUN ASSEMBLY

- 2.1 This unit is set-up to accept the EZFSG2 gun only.
- 2.2 The EZFSG2 has three connection points at the back of the spool gun. (1) The gas connection is a slide on quick connector. (2) The weld power connection has a round ring connection. (3) The trigger connection is the 5-Pin snap on connector.



- 2.3 Carefully slide the weld power connection through the Spool Gun weld cable access opening in the front of the machine.

2.4 Open the wire compartment door.

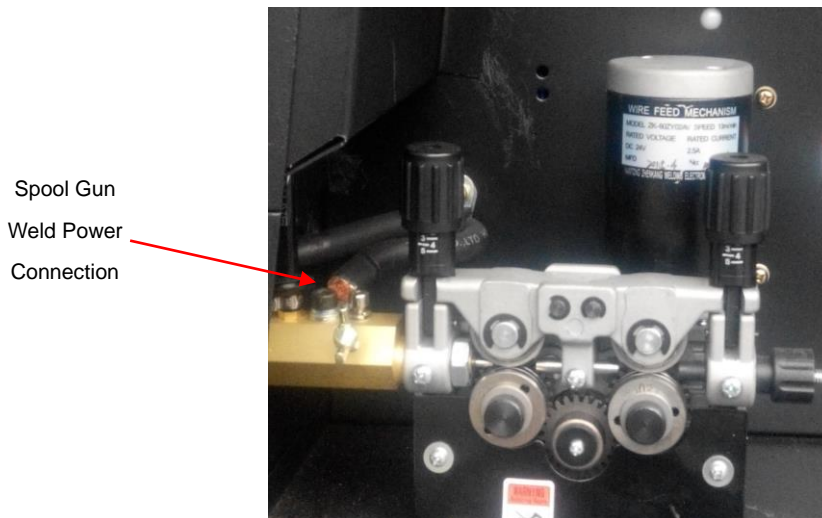

2.5 Connect the weld power connection to the bolt on the side of the MIG connector.

2.6 Connect the Spool Gun 5-Pin trigger connector to the Spool Gun 5-Pin receptacle on the front of the machine.

2.7 Connect the Spool Gun Quick Connect Gas Connector to the Spool Gun Gas Connection on the front of the machine.

3. OPTIONAL DC STICK WELDING ASSEMBLY

▲ CAUTION

- Be aware that the ELECTRODE HOLDER will be electrically HOT when the Input Power Switch on the welder is turned ON.

- 3.1 Install the ground cable quick connector to the negative (-) Weld Output Connector (Figure 8).
- 3.2 Secure the ground clamp to the work piece.
- 3.3 Install the electrode cable quick connector to the positive (+) Weld Output Connector.
- 3.4 Follow the STICK WELDING SET-UP instructions in the Operating Instructions section.

4. OPTIONAL TIG TORCH ASSEMBLY

▲ CAUTION

- Be aware that the TIG TORCH will be electrically HOT when the Input Power Switch on the welder is turned ON.

- 4.1 Remove the ground cable and the electrode holder from the weld output connections. Install the ground cable to the positive (+) weld output connection (Figure 8).
- 4.2 Secure the ground clamp to the work piece.
- 4.3 Connect a regulator to a bottle of ARGON gas. Then connect the gas connection from the TIG torch to the regulator.
- 4.4 Connect the TIG torch weld cable to the negative (-) weld output connection.
- 4.5 Set the desired amperage on the amperage control knob on the front panel of the welder.
- 4.6 Turn on the input power switch on the welder.
- 4.7 Turn on the regulator on the bottle of shielding gas and adjust the regulator to approximately 20 CFH. Open the shielding gas valve on the torch to start the flow of shielding gas.

OPERATING INSTRUCTIONS

▲ WARNING

- **High voltage danger from power source! Consult a qualified electrician for proper installation of receptacle. This welder must be grounded while in use to protect the operator from electrical shock.**
- **Do not remove grounding prong or alter the plug in any way. Use only the supplied adapter between the plasma cutter's power cord and the power source receptacle. Make sure the POWER switch is OFF when connecting your welder's power cord directly to a properly grounded 230 VAC, 60 HZ, Single Phase, 50 Amp input power supply.**

UNDERSTANDING THE FRONT PANEL

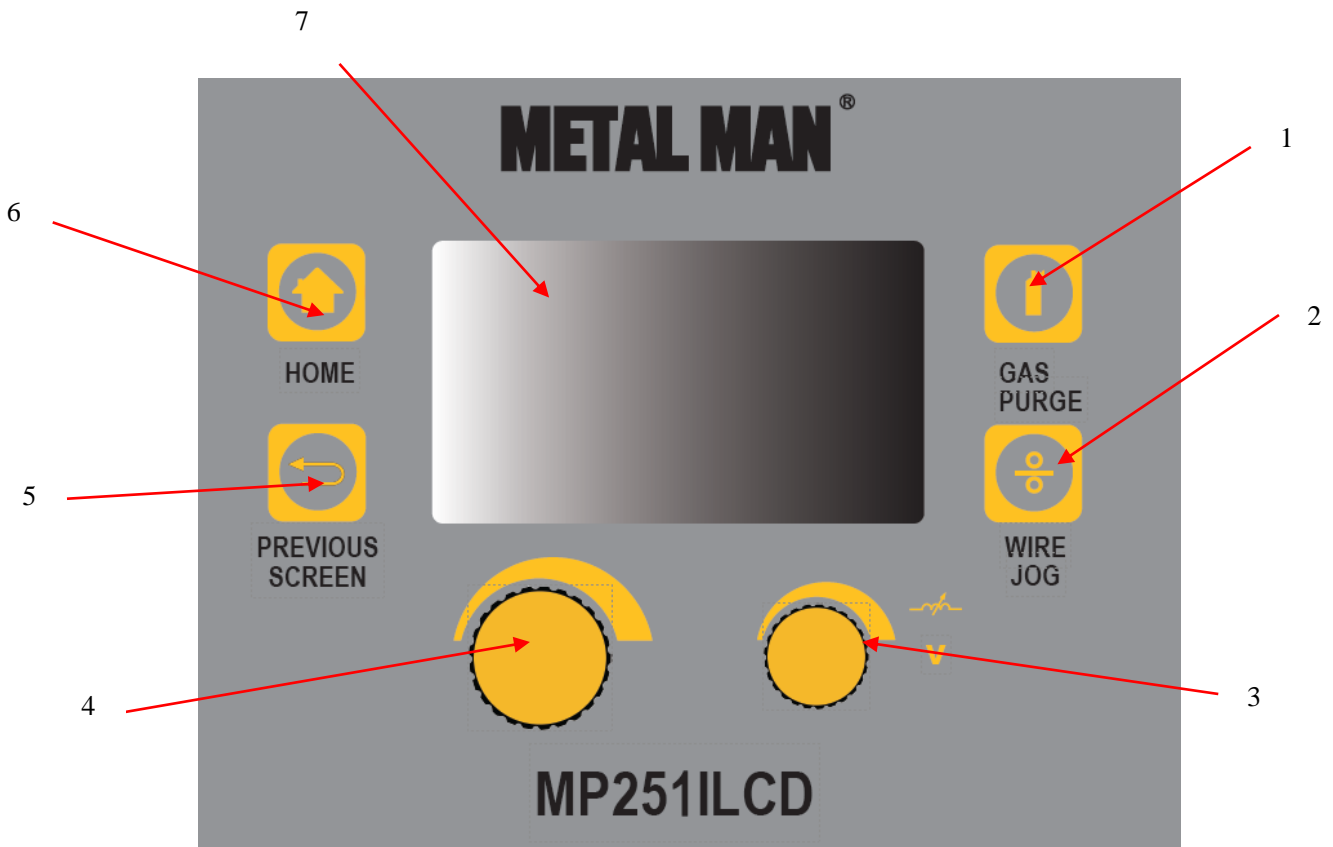

Reference	Description
1	Gas Purge Button
2	Wire Job Button
3	Voltage Control Knob
4	Multi-Function Adjustment/Selection Knob
5	Previous Screen Button
6	Home/Start Button
7	LCD Display

GENERAL SYSTEM SET-UP

1. Press the ENTER BUTTON.
2. Turn the MULTI-FUNCTION ADJUSTMENT/SELECTION KNOB to the SETTING selection.

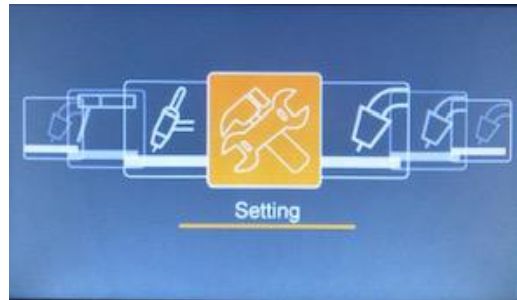

3. Push in the MULTI-FUNCTION ADJUSTMENT/SELECTION KNOB.
4. Language

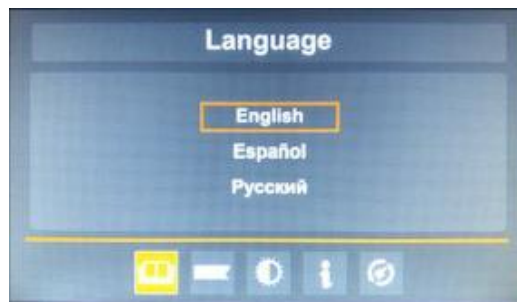

- a. Press the MULTI-FUNCTION ADJUSTMENT/SELECTION KNOB to change the orange outline to solid orange background.
- b. Turn the MULTI-FUNCTION ADJUSTMENT/SELECTION KNOB to ENGLISH.
- c. Press the MULTI-FUNCTION ADJUSTMENT/SELECTION KNOB to Select.

5. Units



- a. Turn the MULTI-FUNCTION ADJUSTMENT/SELECTION KNOB to the units screen.
- b. Press the MULTI-FUNCTION ADJUSTMENT/SELECTION KNOB to change the orange outline to solid orange background.
- c. Turn the MULTI-FUNCTION ADJUSTMENT/SELECTION KNOB to the unit of measure you would like to use.
- d. Press the MULTI-FUNCTION ADJUSTMENT/SELECTION KNOB to Select.

6. Brightness



- a. Turn the MULTI-FUNCTION ADJUSTMENT/SELECTION KNOB until BRIGHTNESS screen is displayed.
- b. Push in the MULTI-FUNCTION ADJUSTMENT/SELECTION KNOB so the brightness setting has an orange background.
- c. Turn the MULTI-FUNCTION ADJUSTMENT/SELECTION KNOB to selected desired screen brightness.
- d. Push in the MULTI-FUNCTION ADJUSTMENT/SELECTION KNOB to select.

7. To read software version



- a. Turn the MULTI-FUNCTION ADJUSTMENT/SELECTION KNOB until INFORMATION screen is displayed.

8. To perform a Factory Reset

⚠ CAUTION

Factory Reset Can Not Be Undone – A factory reset will reset this unit to the condition it was in when you received this unit. Any saved programming will be lost.



- a. Turn the MULTI-FUNCTION ADJUSTMENT/SELECTION KNOB until FACTORY RESET screen is displayed.
- b. Press the MULTI-FUNCTION ADJUSTMENT/SELECTION KNOB to change the orange outline to solid orange background.
- c. Turn the MULTI-FUNCTION ADJUSTMENT/SELECTION KNOB to choose YES or NO for a factory reset.
- d. Push in the MULTI-FUNCTION ADJUSTMENT/SELECTION KNOB to select.
- e. Press the ENTER button to return to the main screen.

WIRE WELDING SET-UP

1. Press the ENTER BUTTON.
2. Turn the MULTI-FUNCTION ADJUSTMENT/SELECTION KNOB to the SETTING selection you need. Press in the MULTI-FUNCTION ADJUSTMENT/SELECTION KNOB to make your selection.
 - a. MIG Steel
 - i. Choose what shielding gas you will be using



- a. MIG Stainless Steel



- c. MIG Al (Aluminum)
 - i. Choose if you will be using a spool gun.
 - ii. Choose which wire alloy you will be using.



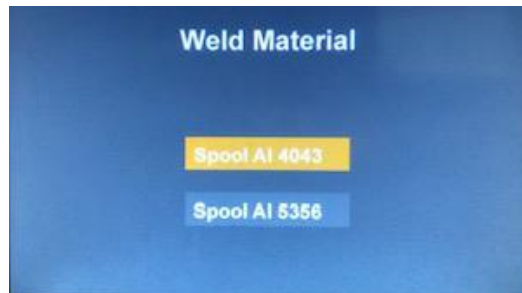

NOTE: WELDING ALUMINUM WITH THE MIG GUN CAN BE DIFFICULT. We always suggest the use of a spool gun to avoid feeding problems associated with a soft aluminum wire.

d. MIG CuSi (Copper/Silicon Alloy)



e. Manual MIG

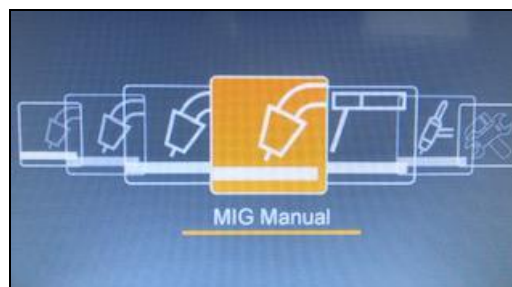

3. Follow the on-screen display that shows the weld cable connections

- a. For MIG Steel with shielding gas – Connect the WELD POWER CABLE to the Positive (+) weld output connection. Then the ground cable to the Negative (-) weld output connection.



- b. For MIG Steel without shielding gas – Connect the WELD POWER CABLE to the Negative (-) weld output connection. Then the ground cable to the Positive (+) weld output connection.



- c. For MIG Stainless, MIG Al, Manual MIG – Connect the WELD POWER CABLE to the Positive (+) weld output connection. Then the ground cable to the Negative (-) weld output connection.

NOTE: WHEN USING A SPOOL GUN FOR ALUMINUM follow the Spool Gun Assembly instructions.



4. For Manual MIG – Skip to step 7. All others go on to step 5.

5. Choose Wire Size

- a. Turn the MULTI-FUNCTION ADJUSTMENT/SELECTION KNOB to the wire size you need. Press in the MULTI-FUNCTION ADJUSTMENT/SELECTION KNOB to make your selection.



6. Choose the thickness of material

- a. Turn the MULTI-FUNCTION ADJUSTMENT/SELECTION KNOB to change the thickness of material. Press in the MULTI-FUNCTION ADJUSTMENT/SELECTION KNOB to make your selection.



7. Your Welder is now ready to weld!
8. Fine Tuning Parameters – The set-up process is designed to get the welder set up into a good welding condition for the material you are welding. You may choose to adjust the parameters to meet your individual weld need.
9. Adjusting Wire Speed (Inch/Min) – When the Inches Per Minute is highlighted in Orange, you can turn the MULTI-FUNCTION ADJUSTMENT/SELECTION KNOB to increase or decrease wire speed.



10. Adjusting Voltage – Adjust voltage by turning the VOLTAGE CONTROL KNOB, the smaller of the two knobs on the front panel.
11. Inductance – We recommend using the programmed inductance setting. However, you do have the option to adjust inductance.
 - a. From the screen above, push in the MULTI-FUNCTION ADJUSTMENT/SELECTION KNOB so the orange highlight turns into an orange outline. Then turn the MULTI-FUNCTION ADJUSTMENT/SELECTION KNOB clockwise until the inductance icon is outlined. Press the MULTI-FUNCTION ADJUSTMENT/SELECTION to highlight in orange.



- b. Adjust inductance Up to increase the arc cycle time, and there by increasing the fluidity or wetting of the puddle. This will result in a wider and more even transition at the toes of the weld.
 - c. Adjust inductance down to increase the short circuit frequency, and there by decreasing puddle fluidity that may result in a narrower and faster freezing puddle.
12. Torch Trigger Options – From the screen above, push in the MULTI-FUNCTION ADJUSTMENT/SELECTION KNOB so the orange highlight turns into an orange outline. Then turn the MULTI-FUNCTION ADJUSTMENT/SELECTION KNOB clockwise until you see Torch Trigger in the middle of the screen. Press the MULTI-FUNCTION ADJUSTMENT/SELECTION KNOB to see Torch Trigger Options.



- a. 2T – No Trigger Hold. Pull and hold the trigger to weld. Release the trigger to stop welding.
- b. 4T – Trigger Hold. Pull and release the trigger once to start the arc, then once again to end the arc. The Trigger Hold allows operators flexibility to not have to hold the trigger during long welds.
- c. Spot time – Pull and Hold the trigger and the arc starts and then stops at a preset time. Used to make multiple spot welds of consistent size and penetration.
- d. Press the MULTI-FUNCTION ADJUSTMENT/SELECTION KNOB to confirm your selection.

13. Pre-Gas Time – Pre-Gas Time allows you to adjust the amount of time that gas will flow when you pull the trigger and before the arc starts. This time should be minimal as a short burst of gas is generally adequate before the arc starts. We recommend using the programmed pre gas setting. However, you do have the option to adjust the pre gas time.

- a. From the screen above, push in the MULTI-FUNCTION ADJUSTMENT/SELECTION KNOB so the orange highlight turns into an orange outline. Then turn the MULTI-FUNCTION ADJUSTMENT/SELECTION KNOB clockwise until you see the Pre-Gas Time in the middle of the screen.
- b. Press the MULTI-FUNCTION ADJUSTMENT/SELECTION KNOB to select.
- c. Turn the MULTI-FUNCTION ADJUSTMENT/SELECTION KNOB to adjust the Pre-Gas Time.





d. Press the MULTI-FUNCTION ADJUSTMENT/SELECTION KNOB to confirm.

14. Run In WFS – Run In WFS allows you to adjust the speed of the wire feeding; after you pull the trigger and just prior to a weld establishing. Wire that “Runs In” slower will generally provide a smoother and less “Poppy” arc starting. We recommend using the programmed Run In WFS setting. However, you do have the option to adjust the Run In WFS

a. From the screen above, push in the MULTI-FUNCTION ADJUSTMENT/SELECTION KNOB so the orange highlight turns into an orange outline. Then turn the MULTI-FUNCTION ADJUSTMENT/SELECTION KNOB clockwise until you see the Run In WFS in the middle of the screen.

b. Press the MULTI-FUNCTION ADJUSTMENT/SELECTION KNOB to select.

c. Turn the MULTI-FUNCTION ADJUSTMENT/SELECTION KNOB to adjust the Run In WFS time.



d. Press the MULTI-FUNCTION ADJUSTMENT/SELECTION KNOB to confirm.

15. Post Gas Time – Post Gas Time allows you to adjust the amount of time that gas will flow after you have released the trigger and the arc has stopped. The purpose of Post Gas is to keep the weld under shielding gas as the puddle solidifies. It can also be used to prolong the contact tip and nozzle life by assisting to cool these items after the weld. We recommend using the programmed Post Gas setting. However, you do have the option to adjust the Post Gas time.

a. From the screen above, push in the MULTI-FUNCTION ADJUSTMENT/SELECTION KNOB so the orange highlight turns into an orange outline. Then turn the MULTI-FUNCTION ADJUSTMENT/SELECTION KNOB clockwise until you see the Post Gas Time in the middle of the screen.

b. Press the MULTI-FUNCTION ADJUSTMENT/SELECTION KNOB to select.

c. Turn the MULTI-FUNCTION ADJUSTMENT/SELECTION KNOB to adjust Post Gas time.



STICK WELDING SET-UP

1. Press the ENTER BUTTON.
2. Turn the MULTI-FUNCTION ADJUSTMENT/SELECTION KNOB until the Stick/MMA screen is displayed.



3. Push in the MULTI-FUNCTION ADJUSTMENT/SELECTION KNOB to confirm your selection.
4. Follow the display set-up:



- a. Connect the Electrode Holder to the Positive (+) Weld Output Connection.
- b. Connect the Ground Cable to the Negative (-) Weld Output Connection.
5. Adjusting Amperage



- a. When the Amperage is highlighted in Orange, you are able to turn the MULTI-FUNCTION ADJUSTMENT/SELECTION KNOB to increase or decrease amperage.
- 6. Push in the MULTI-FUNCTION ADJUSTMENT/SELECTION KNOB to change the orange background to an orange outline.



- 7. Turn the MULTI-FUNCTION ADJUSTMENT/SELECTION KNOB to Hot Start.
- 8. Push in the MULTI-FUNCTION ADJUSTMENT/SELECTION KNOB to confirm your selection.
- 9. Adjusting Hot Start



- a. Hot Start setting can be used to help get hard to start electrodes started easier. It will provide a very short boost of output voltage to help with starting the electrode. Turn the MULTI-FUNCTION ADJUSTMENT/SELECTION KNOB to the desired Hot Start Setting.
- b. Press the MULTI-FUNCTION ADJUSTMENT/SELECTION KNOB to confirm your selection
- 10. Turn the MULTI-FUNCTION ADJUSTMENT/SELECTION KNOB to Arc Force.
- 11. Push in the MULTI-FUNCTION ADJUSTMENT/SELECTION KNOB to confirm your selection.
- 12. Adjusting Arc Force.



- a. Arc Force setting can be used while welding to help keep the electrode from “sticking”. It

will provide a very short boost of output amperage when the arc is too short. Turn the MULTI-FUNCTION ADJUSTMENT/SELECTION KNOB to the desired Arc Force Setting.

- b. Press the MULTI-FUNCTION ADJUSTMENT/SELECTION KNOB to confirm your selection
13. Turn the MULTI-FUNCTION ADJUSTMENT/SELECTION KNOB to VRD.
14. Push in the MULTI-FUNCTION ADJUSTMENT/SELECTION KNOB to confirm your selection.
15. Adjusting VRD



- a. VRD stands for Voltage Reduction Device. It is used to reduce the OCV or Open Circuit Voltage that is present at the weld output connections when not welding.
- b. VRD is a safety function required in some countries and meant to protect the operator should the operator accidentally come in contact with the weld output connections.

DC TIG WELDING SET-UP

1. Press the ENTER BUTTON.
2. Turn the MULTI-FUNCTION ADJUSTMENT/SELECTION KNOB until the LIFT TIG screen is displayed.



3. Push in the MULTI-FUNCTION ADJUSTMENT/SELECTION KNOB to confirm your selection.
4. Follow the display set-up:

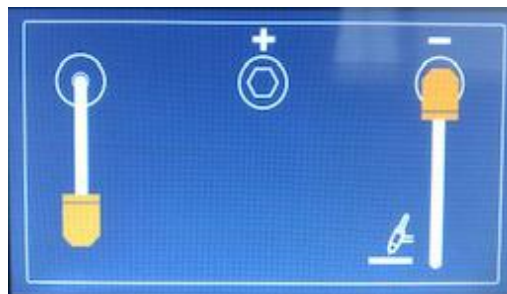

- a. Connect the TIG torch to the Negative (-) Weld Output Connection.
- b. Connect the Ground Cable to the Positive (+) Weld Output Connection
5. Adjusting Amperage



- a. Turn the MULTI-FUNCTION ADJUSTMENT/SELECTION KNOB to increase or decrease amperage.

NOTE: This unit is automatically in the LIFT TIG setting. This unit does not have the remote-control facilities or the HF requirement necessary to perform HF starts with a foot pedal.

MIG OPERATION

1. POWER SWITCH - The power switch supplies electrical current to the welder. Whenever the power switch is in the ON position, the welding circuit is activated. ALWAYS turn the power switch to the OFF position and unplug the welder before performing any maintenance.
2. HOLDING THE TORCH - The best way to hold the welding torch is the way it feels most comfortable to you. While practicing using your new welder, experiment holding the torch in different positions until you find the one that seems to work best for you.
3. POSITION OF THE TORCH TO THE WORK PIECE - There are two angles of the torch nozzle in relation to the work piece that must be consider when welding.
 - a. Angle a can be varied, but in most cases the optimum angle will be 60 degrees, the point at which the torch angle is parallel to the work piece. If angle A is increased, penetration will increase. If angle A is decreased, penetration will decrease also.

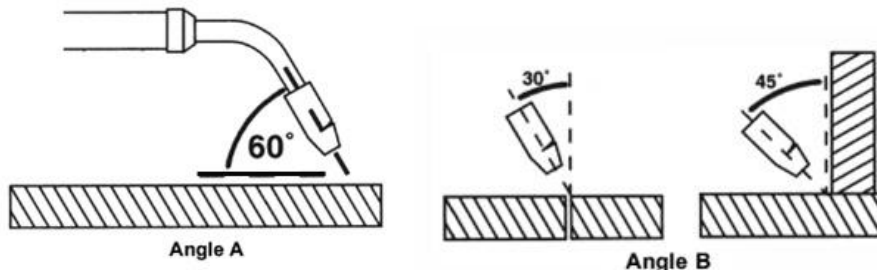

- b. Angle B can be varied for two reasons: to improve the availability to see the arc in relation to the weld puddle and to direct the force of the arc.
 - c. DISTANCE FROM THE WORK PIECE - If the nozzle is held off the work piece, the distance between the nozzle and the work piece should be kept constant and should not exceed 1/4 inch or the arc may begin sputtering, signaling a loss in welding performance.
 - d. TUNING IN THE WIRE SPEED - This is one of the most important parts of wire welder operation and must be done before starting each welding job or whenever the voltage setting, or wire diameter is changed.

▲ WARNING

EXPOSURE TO A WELDING ARC IS EXTREMELY HARMFUL TO THE EYES AND SKIN! Prolonged exposure to the welding arc can cause blindness and burns. Never strike an arc or begin welding until you are adequately protected. Wear flame-proof welding gloves, a heavy long-sleeved shirt, trousers without cuffs, high topped shoes, and an ANSI approved welding helmet.

- e. Connect the Ground Clamp to a scrap piece of the same type of material which you will be welding. It should be equal to or greater than the thickness of the actual work piece, and free of oil, paint, rust, etc.
- f. Select a heat setting.
- g. Hold the torch in one hand. Hold the wire just off the work piece. (See step 2 above: HOLDING THE TORCH, if you are uncertain of the angle at which you will be welding.)
- h. Set the wire feed speed based on the thickness of material and the set-up chart on the back side of the wire feeder door.
- i. Lower your welding helmet and pull the trigger on the torch and let the wire feed into the work piece to start an arc, and then begin to drag the torch toward you.
- j. LISTEN! If the arc is sputtering, increase the wire speed slightly and try again. Continue increasing the wire speed adjustment until you achieve a smooth buzzing sound. If the wire seems to "pound" into the work piece, decrease wire speed slightly and try again. Use the wire speed control to slightly increase or decrease the heat and penetration for a given voltage setting by increasing or decreasing the wire speed slightly. Repeat this tune-in procedure if you select a new voltage setting, a different wire diameter, or a different roll of wire.

4. WELDING TECHNIQUES

▲ WARNING

EXPOSURE TO A WELDING ARC IS EXTREMELY HARMFUL TO THE EYES AND SKIN! Prolonged exposure to the welding arc can cause blindness and burns. Never strike an arc or begin welding until you are adequately protected. Wear flame-proof welding gloves, a heavy long-sleeved shirt, trousers without cuffs, high topped shoes, and an ANSI approved welding helmet.

▲ WARNING

ELECTRIC SHOCK CAN CAUSE INJURY OR DEATH! To prevent ELECTRIC SHOCK, do not perform any welding while standing, kneeling, or lying directly on the grounded workpiece.

- a. **Moving the Torch** - Torch travel refers to the movement of the torch along the weld joint and is broken into two elements: direction and speed. A solid weld bead requires that the welding torch be moved steadily and at the right speed along the weld joint. Moving the torch too fast, too slow, or erratically will prevent proper fusion or create a lumpy, uneven bead.

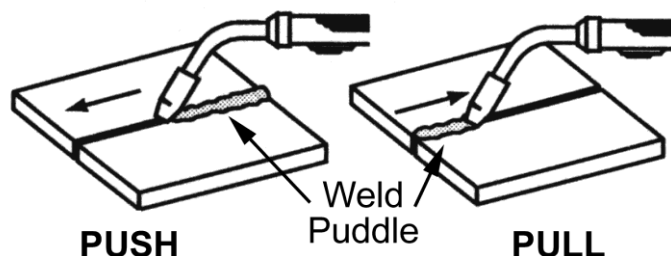

Travel direction is the direction the torch is moved along the weld joint in relation to the weld puddle. The torch is either PUSHED into the weld puddle or PULLED away from the weld puddle.

For most welding jobs you will pull the torch along the weld joint to take advantage of the greater weld puddle visibility.

Travel speed is the rate at which the torch is being pushed or pulled along the weld joint. For a fixed heat setting, the faster the travel speed, the lower the penetration and the lower and narrower the finished weld bead. Likewise, the slower the travel speed, the deeper the penetration and the higher and wider the finished weld bead will be.

b. Types of Welding Beads - As you become more familiar with your new welder and better at laying some simple weld beads, you can begin to try some different weld bead types.

The **STRINGER BEAD** is formed by traveling with the torch in a straight line while keeping the wire and nozzle centered over the weld joint. See following figure.

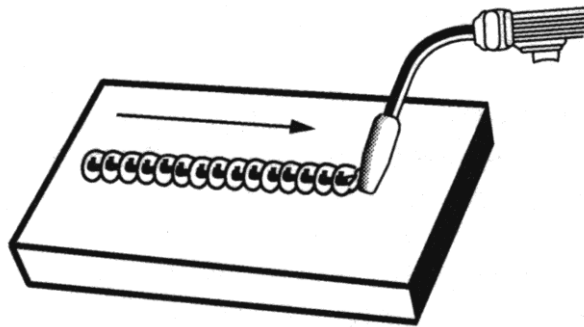

The **WEAVE BEAD** is used when you want to deposit metal over a wider space than would be possible with a stringer bead. It is made by weaving from side to side while moving with the torch. It is best to hesitate momentarily at each side before weaving back the other way.

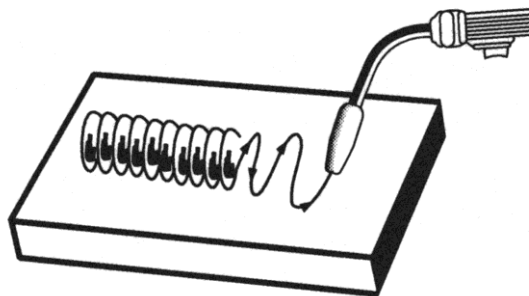

c. Welding Positions

The **FLAT POSITION** is the easiest of the welding positions and is most commonly used. It is best if you can weld in the flat position, if at all possible, as good results are easier to achieve.

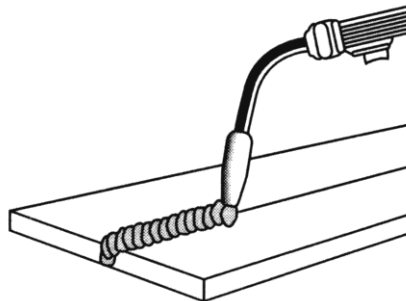

The **HORIZONTAL POSITION** is performed very similarly to the flat weld except that angle B (see **HOLDING THE TORCH**) is such that the wire, directed more toward the metal above the weld joint, is to help prevent the weld puddle from running downward while still allowing slow enough travel speed. A good starting point for angle B is about 30 degrees **DOWN** from being perpendicular to the work piece.

VERTICAL POSITION it is easier for many people to pull the torch from top to bottom. It can be difficult to prevent the puddle from running downward. Pushing the torch from bottom to top may provide better puddle control and allow slower rates of travel speed to achieve deeper penetration. When vertical welding, angle B (see HOLDING THE TORCH) is usually always kept at zero, but angle A will generally range from 45 to 60 degrees to provide better puddle control.



The OVERHEAD POSITION is the most difficult welding position. Angle A (see HOLDING THE TORCH) should be maintained at 60 degrees. Maintaining this angle will reduce the chances of molten metal falling into the nozzle. Angle B should be held at zero degrees so that the wire is aiming directly into the weld joint. If you experience excessive dripping of the weld puddle, select a lower heat setting. Also, the weave bead tends to work better than the stringer.

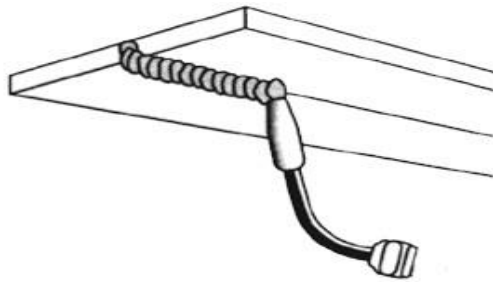

d. Multiple Pass Welding

Butt Weld Joints When butt welding thicker materials; you will need to prepare the edges of the material to be joined by grinding a bevel on the edge of one or both pieces of the metal being joined. When this is done, a “V” is created between the two pieces of metal that will have to be welded closed. In most cases more than one pass or bead will need to be laid into the joint to close the “V”.

Laying more than one bead into the same weld joint is known as a multiple-pass weld.

The illustrations in the following figure show the sequence for laying multiple pass beads into a single “V” butt joint.

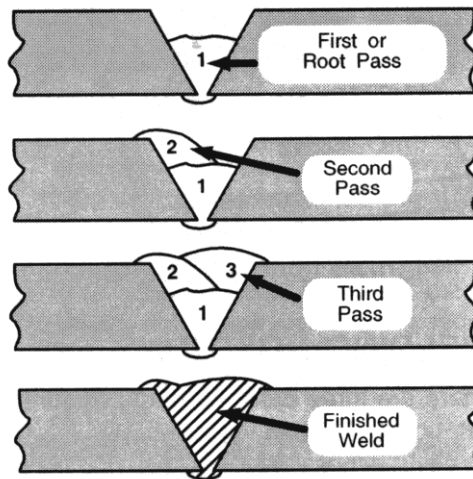

NOTE: WHEN USING SELF-SHIELDING FLUX-CORE WIRE it is very important to thoroughly chip and brush the slag off each completed weld bead before making another pass or the next pass will be of poor quality.

Fillet Weld Joints. Most fillet weld joints, on metals of moderate to heavy thickness, will require multiple pass welds to produce strong joint. The following figure will show the sequence of laying multiple pass beads into a T fillet joint and a lap fillet joint.

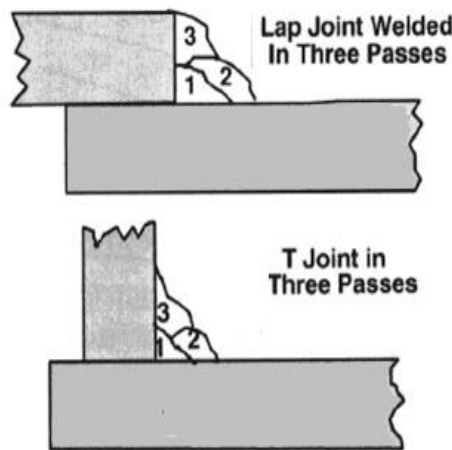

e. Spot Welding

There are three methods of spot welding: Burn-Through, Punch and Fill, and Lap. Each has advantages and disadvantages depending on the specific application as well as personal preference.



- i. The BURN-THROUGH METHOD welds two overlapped pieces of metal together by burning through the top piece and into the bottom piece. With the burn-through method, larger wire diameters tend to work better than smaller diameters. Wire diameters that tend to work best, with the burn-through method

are 0.035-inch self-shielding flux-core wire. Do not use 0.030-inch self-shielding flux core wires when using the burn-through method unless the metal is VERY thin or excessive filler metal build-up and minimal penetration is acceptable. Always select the HIGH heat setting with the burn-through method and tune in the wire speed prior to making a spot weld.

- ii. The PUNCH AND FILL METHOD produces a weld with the most finished appearance of the three spot weld methods. In this method, a hole is punched or drilled into the top piece of metal and the arc is directed through the hole to penetrate the bottom piece. The puddle can fill up the hole leaving a spot weld that is smooth and flush with the surface of the top piece. Select the wire diameter, heat setting, and tune in the wire speed as if you were welding the same thickness material with a continuous bead.
- iii. The LAP SPOT METHOD directs the welding arc to penetrate the bottom and top pieces, at the same time, right along each side of the lap joint seam. Select the wire diameter, heat setting, and tune in the wire speed as if you were welding the same thickness material with a continuous bead.

5. SPOT WELDING INSTRUCTIONS

- a. Select the wire diameter and heat setting recommended above for the method of spot welding you intend to use.
- b. Tune in the wire speed as if you were going to make a continuous weld.
- c. Hold the nozzle piece completely perpendicular to and about 1/4 inch off the work piece.
- d. Pull the trigger on the torch and release it when it appears that the desired penetration has been achieved.
- e. Make practice spot welds on scrap metal, varying the length of time you hold the trigger, until a desired spot weld is made.
- f. Make spot welds on the actual work piece at desired locations.

DC STICK OPERATION

▲ WARNING

- ***High voltage danger from power source! Consult a qualified electrician for proper installation of receptacle. This welder must be grounded while in use to protect the operator from electrical shock.***
- ***Do not remove grounding prong or alter the plug in any way. Use only the supplied adapter between the plasma cutter's power cord and the power source receptacle. Make sure the POWER switch is OFF when connecting your welder's power cord directly to a properly grounded 230 VAC, 60 HZ, Single Phase, 50 Amp input power supply. Or, when using the supplied 120V adapter, connect the 120V Adapter to a properly grounded 120V, 20 Amp input power supply.***

1. SETTING UP THE WORK PIECE

- a. Welding positions - There are two basic positions, for welding: Flat and Horizontal. Flat welding is generally easier, faster, and allows for better penetration. If possible, the work piece should be positioned so that the bead will run on a flat surface.
- b. Preparing the Joint- Before welding, the surface of work piece needs to be free of dirt, rust, scale, oil, or paint or it will create brittle and porous welds. If the base metal pieces to be joined are thick or heavy, it may be necessary to bevel the edges with a metal grinder;

the correct bevel should be around 60 degrees. See the following illustration:

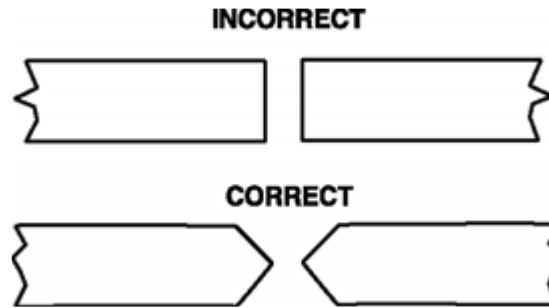

Based on different welding positions, there are different welding joints. See the following illustration for more information.

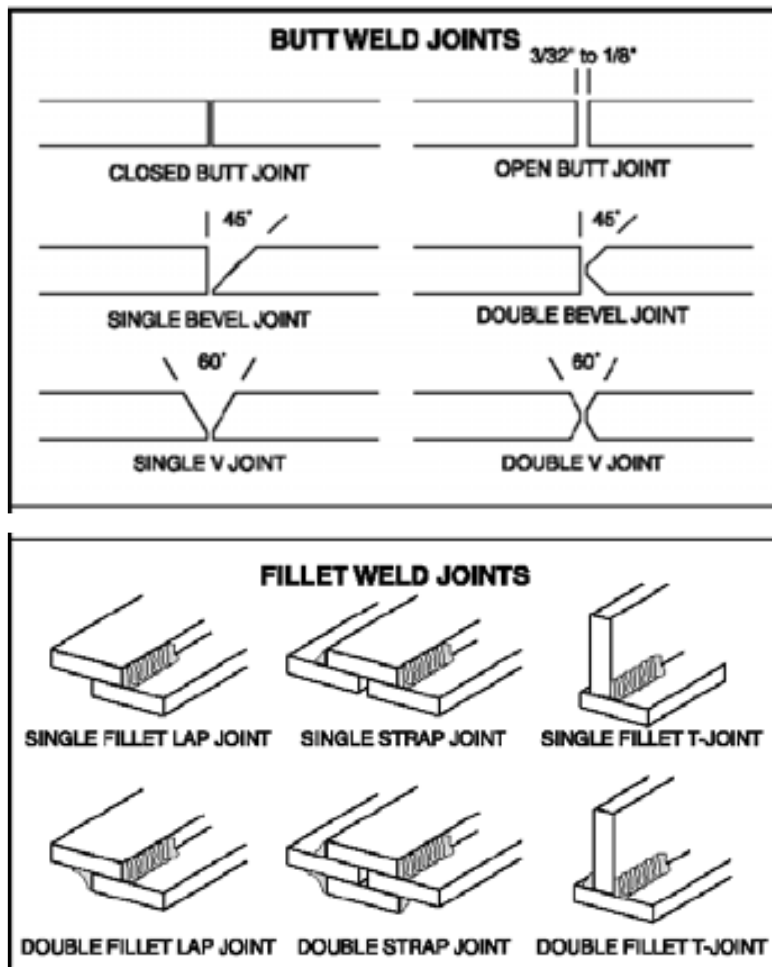

2. GROUND CLAMP CONNECTION

Clear any dirt, rust, scale, oil, or paint on the ground clamp. Make certain you have a good solid ground connection. A poor connection at the ground clamp will waste power and heat. Make sure the ground clamp touches the metal.

3. ELECTRODE

The welding electrode is a rod coated with a layer of flux. When welding, electrical current flows between the electrode (rod) and the grounded metal work piece. The intense heat of the arc between the rod and the grounded metal melts the electrode and the flux.

4. SELECTING THE PROPER ELECTRODE

There is no golden rule that determines the exact rod or heat setting required for every situation. The type and thickness of metal and the position of the work piece determine the electrode type and the amount of heat needed in the welding process. Heavier and thicker metals require more amperage. It is best to practice your welds on scrap metals which match the metal you intend to work with to determine correct heat setting and electrode choice. See the following helpful trouble shooting tips to determine if you are using a correct electrode.

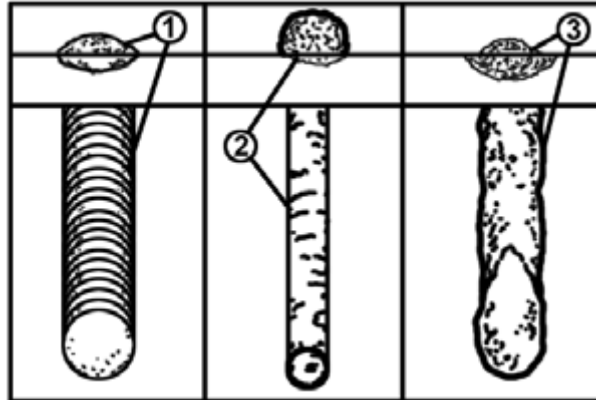

a. When the proper rod is used:

- i. The bead will lay smoothly over the work without ragged edges.
- ii. The base metal puddle will be as deep as the bead that rises above it.
- iii. The welding operation will make a crackling sound like the sound of eggs frying.

b. When a rod is too small is used:

- i. The bead will be high and irregular.
- ii. The arc will be difficult to maintain.

c. When the rod is too large:

- i. The arc will burn through light metals.
- ii. The bead will undercut the work.
- iii. The bead will be flat and porous.
- iv. The rod may be freeze or stick to the work piece.

Note: The rate of travel over the work also affects the weld. To ensure proper penetration and enough deposit of rod, the arc must be moved slowly and evenly along the weld seam.

5. SETTING THE AMPERAGE CONTROL

The welder has an infinite current control. It is capable of welding with electrodes up to 3/32" diameter. It is best to practice your welds on scrap metals which match the metals you intend to work with to determine correct setting for your job. The electrode type and the thickness of the work piece metal determine the amount of heat needed in the welding process. Heavier and thicker metals require more voltage (amperage), whereas lighter and thinner metals require less voltage (amperage). Consult the welding electrode packaging for recommended welding amperage range.

6. WELDING TECHNIQUES

The best way to teach yourself how to weld is with short periods of practice at regular intervals. All practice welds should be done on scrap metal that can be discarded. Do not attempt to make any repairs on valuable equipment until you have satisfied yourself that your practice welds are of good appearance and free of slag or gas inclusions.

a. Holding the electrode

The best way to grip the electrode holder is the way that feels most comfortable to you. Position the electrode to the work piece when striking the initial arc, it may be necessary to hold the electrode perpendicular to the work piece. Once the arc is started the angle of the electrode in relation to the work piece should be between 10 and 30 degrees. This will allow for good penetration, with minimal spatter.

▲ WARNING

EXPOSURE TO A WELDING ARC IS EXTREMELY HARMFUL TO THE EYES AND SKIN! Prolonged exposure to the welding arc can cause blindness and burns. Never strike an arc or begin welding until you are adequately protected. Wear flame-proof welding gloves, a heavy long-sleeved shirt, trousers without cuffs, high topped shoes, and an ANSI approved welding helmet.

▲ WARNING

ELECTRIC SHOCK CAN CAUSE INJURY OR DEATH! To prevent ELECTRIC SHOCK, do not perform any welding while standing, kneeling, or lying directly on the grounded workpiece.

b. Striking the arc

Scratch the work piece with the end of electrode to start arc and then raise it quickly about 1/8-inch gap between the rod and the work piece, see following picture:

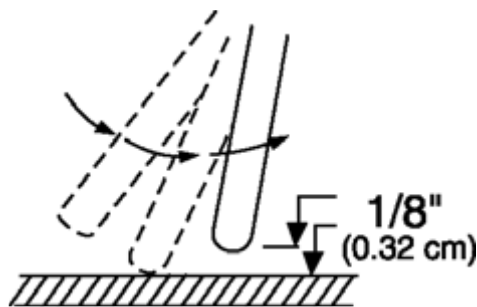

It is important that the gap be maintained during the welding process, and it shouldn't be too wide or too narrow. If it's too narrow, the rod will stick to the work piece. If it's too wide, the arc will be extinguished. It needs much practice to maintain the gap. Beginners may get sticker or arc extinguishing. When the rod is stuck to the work piece, gently rock it back and forth to separate them. If not, a short circuit will occur, and it will break the welder. A good arc is accompanied by a crisp, cracking sound (eggs frying). To lay a weld bead, only two movements are required: downward (as the electrode is consumed) and in the direction the weld is to be laid, as in the following figure:

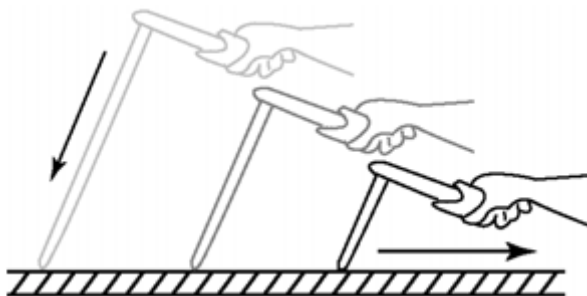

c. Types of weld bead

The following paragraphs discuss the most commonly used arc welding beads.

The stringer bead is formed by traveling with the electrode in a straight line while keeping the electrode centered over the weld joint.

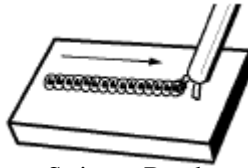

Stringer Bead

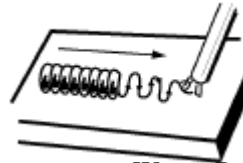

Weave Bead

The weave bead is used when you want to deposit metal over a wider space than would be possible with a stringer bead. It is made by weaving from side to side while moving with the electrode. It is best to hesitate momentarily at each side before weaving back the other way.

d. Welding position

Flat position is the easiest of the welding positions and is most commonly used. It is best if you can weld in the flat position, if at all possible, as good results are easier to achieve.



Flat Position

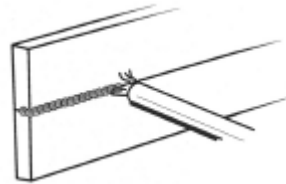

Horizontal Position

The horizontal position is performed very much the same as the flat weld except that the angle is different such that the electrode, and therefore the arc force, is directed more toward the metal above the weld joint. This more direct angle helps prevent the weld puddle from running downward while still allowing slow enough travel speed to achieve good penetration. A good starting point for your electrode angle is about 30 degrees DOWN from being perpendicular to the work piece.

e. Judge the good weld bead

When the trick of establishing and holding an arc has been learned, the next step is learning how to run a good bead. The first attempts in practice will probably fall short of acceptable weld beads. Too long of an arc will be held or the travel speed will vary from slow to fast (see following).

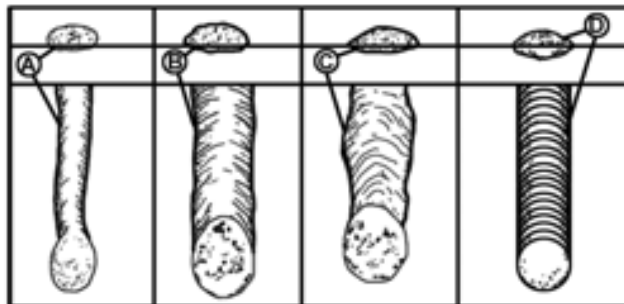

A. Weld speed is too fast.

B. Weld speed is too slow.

C. Arc is too long.

D. Ideal weld.

A solid weld bead requires that the electrode be moved slowly and steadily along the weld

seam. Moving the electrode rapidly or erratically will prevent proper fusion or create a lumpy, uneven bead.

f. Finish the bead

As the coating on the outside of the electrode burns off, it forms an envelope of protective gases around the weld. This prevents air from reaching the molten metal and creating an undesirable chemical reaction. The burning coating, however, forms slag. The slag formation appears as an accumulation of dirty metal scale on the finished weld. Slag should be removed by using a chipping hammer.

▲ WARNING

PEENING THE SLAG FROM A WELD JOINT CAUSES SMALL CHIPS OF METAL TO FLY THROUGH THE AIR! Metallic chips flying through the air can cause eye injury or injury to other parts of the head, hands or exposed portions of the body. Wear goggles or safety glasses with side shields and protect the hands and other exposed parts of the body with protective garments, or if possible, work with a shield between the body and the work piece.

The intense heat produced at the arc sets up strains in the metal joined by welding. Peening the weld not only removes the scale left behind in the welding but relieves the internal strains developed by the heating and cooling process.

DC TIG OPERATION

▲ WARNING

- ***High voltage danger from power source! Consult a qualified electrician for proper installation of receptacle. This welder must be grounded while in use to protect the operator from electrical shock.***
- ***Do not remove grounding prong or alter the plug in any way. Use only the supplied adapter between the plasma cutter's power cord and the power source receptacle. Make sure the POWER switch is OFF when connecting your welder's power cord directly to a properly grounded 230 VAC, 60 HZ, Single Phase, 50 Amp input power supply. Or, when using the supplied 120V adapter, connect the 120V Adapter to a properly grounded 120V, 20 Amp input power supply.***

▲ WARNING

EXPOSURE TO A WELDING ARC IS EXTREMELY HARMFUL TO THE EYES AND SKIN! Prolonged exposure to the welding arc can cause blindness and burns. Never strike an arc or begin welding until you are adequately protected. Wear flame-proof welding gloves, a heavy long-sleeved shirt, trousers without cuffs, high topped shoes, and an ANSI approved welding helmet.

▲ CAUTION

Be aware that the TIG torch will be electrically HOT when the Input Power Switch on the welder is turned on.

1. Remove the ground cable and the electrode holder from the weld output connections. Install the ground cable to the Positive (+) weld output connection.
2. Secure the ground clamp to the work piece
3. Connect a regulator to a bottle of ARGON gas. Then connect the gas connection from the TIG torch to the regulator.
4. Connect the TIG torch weld cable to the Negative (-) weld output connection.
5. Set desired amperage on the amperage control knob on the front panel of the welder.

6. Turn on the input power switch on the welder.
7. Turn on the regulator on the bottle of shielding gas and adjust the regulator to approximately 20 CFH. Then open the shielding gas valve on the torch to start the flow of shielding gas.
8. Follow these steps for striking an arc while TIG welding.
 - a. Open the shielding gas valve on the torch handle to begin gas flow.
 - b. Rest the TIG torch nozzle on the work piece taking care to not touch the installed tungsten electrode.

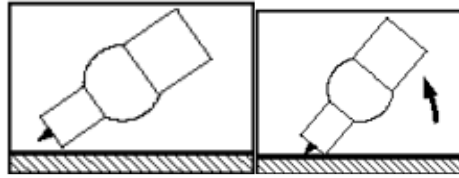

- c. Twist the torch to make contact between the work piece and the tungsten.
- d. Lift torch away from the work piece about 1/8 inch.

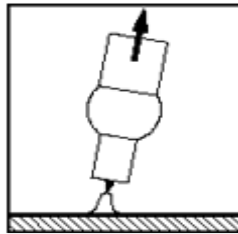

- e. Move down the joint to be welded by pushing the torch.
- f. Insert filler metal in the leading edge of the weld puddle as needed.

MAINTENANCE

- **Maintain your welder.** It is recommended that the general condition of any welder be examined before it is used. Keep your welder in good repair by adopting a program of conscientious repair and maintenance. Have necessary repairs made by qualified service personnel.
- Periodically clean dust, dirt, grease, etc. from your welder.
- Every six months, or as necessary, remove the cover panel from the welder and air-blow any dust and dirt that may have accumulated inside the welder.
- Replace power cord, ground cable, ground clamp, or electrode assembly when damaged or worn.

TROUBLESHOOTING

Failure	Possible Cause	Corrective Action
Unit Does Not Power Up.	Unit is not plugged in.	Plug in unit.
	Input power circuit breaker is not on.	Reset input power circuit breaker.
	The main power switch is not working.	Replace main power switch.
Protection Indicator Is On.	The internal temperature is too high.	Leave power on and let the fan cool the unit. Output will continue when the unit has cooled.
	Input power voltage is too high or too low.	Meter input power voltage. This unit must be used with input voltage that ranges from 230V AC plus or minus 15%.
	Cooling fan is damaged.	Replace the cooling fan.
Wire Drive Motor Does Not Turn.	Wire feed speed control at zero.	Increase wire feed speed control.
	Trigger is not mashed.	Wire will feed only when trigger is mashed.
	Wire drive motor Is damaged.	Replace wire drive motor.
	Feed roller is not correctly installed.	See installation section to correctly install the drive roller.
Wire Feeds Inconsistently.	Torch liner is plugged.	Clear or replace torch liner.
	Wire diameter may vary on spool of wire causing the wire to catch in the contact tip.	Increase the contact tip one size.
	Too much or too little wire tension.	See Installing the Wire section.
	Too much or too little drive roll tension.	See Setting Drive Roll Tension section.
	Drive roll is worn.	Replace drive roll.
Cannot Create an Arc. Welding Arc is Unstable, Creating Excessive Spatter.	Work piece is painted or rusty.	Remove all paint and rust.
	Ground clamp is connected where there is paint or rust.	Remove all paint and rust so ground clamp is connected to bare metal.
	Ground clamp is not electrically connected to the work piece.	Make certain the ground clamp Is connected to the work piece.
	Trigger Is not mashed.	When in the MIG mode, this unit is not electrically hot until you mash the torch trigger.
	Stick or TIG welding and machine is set for MIG welding.	Make certain the SPOOL GUN/MIG TORCH/STICK WELDING selector switch is in the STICK position.
	The contact tip is too large.	Make certain the correct contact tip is installed.

Failure	Possible Cause	Corrective Action
	Torch liner is plugged.	Clear or replace torch liner.
	No shielding gas.	Connect shielding gas supply and turn shielding gas on.
	MIG torch is not correctly installed and shielding gas is not transferring to the arc.	Remove and reconnect the MIG torch to make certain it is completely installed into the MIG connector.
	Wire speed setting is incorrect.	Refer to the label inside the wire compartment door for wire speed setting recommendations.
	Voltage setting is incorrect.	Refer to the label inside the wire compartment door for voltage setting recommendations.
For Assistance, Contact the Welder Help Line at 888-762-4045		

DIAGRAM

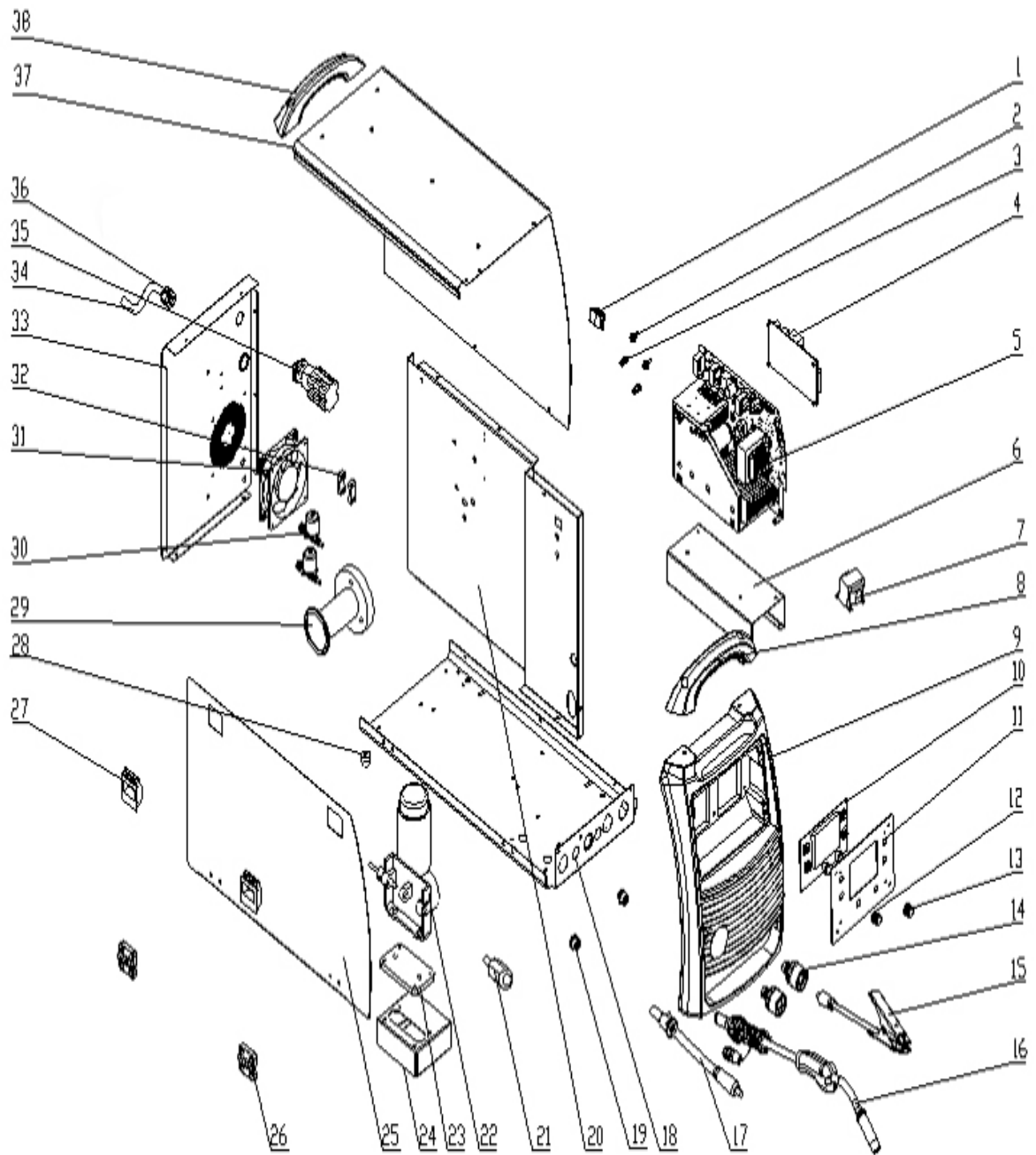

PARTS LIST

Reference	Part Number	Part Description	Quantity
1	105200327	TORCH SELECTION SWITCH	1
2	105200328	MALE GAS QUICK CONNECT	2
3	105200052	FEMALE GAS QUICK CONNECT	2
4	105200292	Control PCB	1
5	105200293	Main PCB	1
6	105200294	Main PCB Support Bracket	1
7	105200295	Reactor	1
8	105200296	Handle	1
9	105200297	Plastic Front Bezel	1
10	105200298	LCD Control PCB	1
11	105200299	LCD Support Panel	1
12	145200040	Potentiometer Knob (Yellow)	1
13	145200041	Potentiometer Knob (Yellow)	1
14	105200136	Quick Connector	2
15	105200060	Ground Cable & Clamp	1
16	105200148	MIG Torch	1
17	105200301	Polarity Selector Weld Cable	1
18	105200302	Bottom	1
19	105200277	5-PIN TRIGGER RECEPTACLE	1
20	105200303	Middle Support Panel	1
21	105200055	MIG Block	1
22	105200329	Wire Feed Drive Assembly	1
23	105200284	Wire Feeder Isolation Panel	1
24	105200304	Wire Feeder Support Panel	1
25	145200042	Door	1
26	105200120	Hinge	2
27	105200080	Door Latch	2
28	105500033	Machine feet	4
29	105200114	Wire Spool Holder	1
30	105200305	Gas Valve	2
31	105200306	Fan	1
32	105200307	Strain Relief	2
33	105200308	Back Panel	1
34	105200309	Power Cable	1
35	105200310	Power Switch	1
36	105200311	Strain Relief	1
37	145200043	Enclosure	1
38	105200296	Handle	1

DIAGRAM

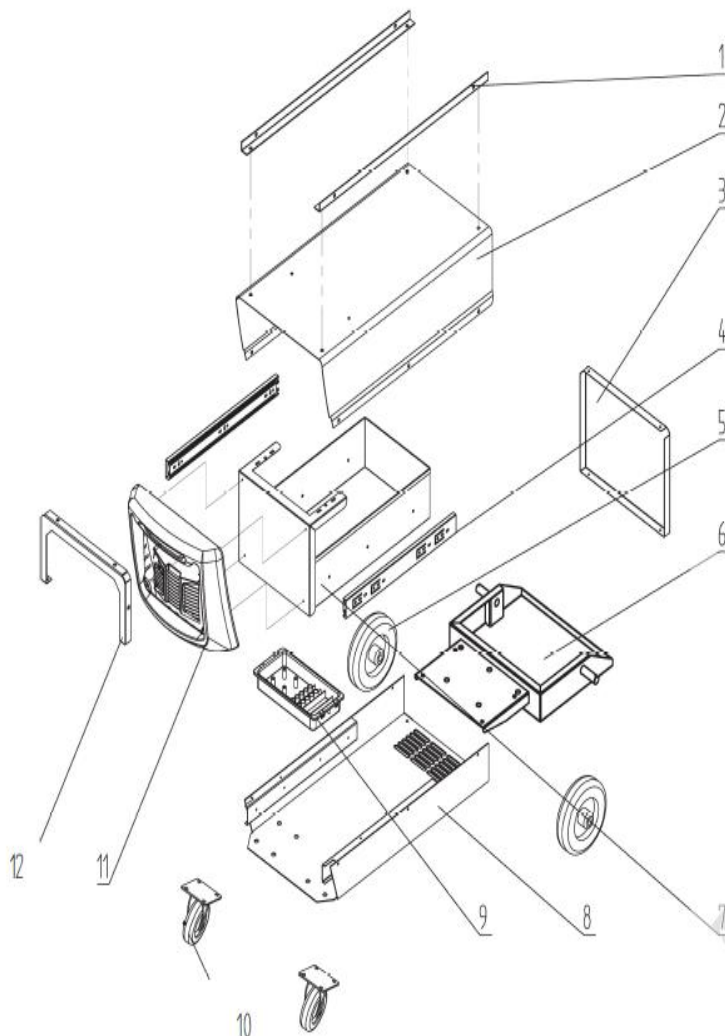

PARTS LIST

Reference	Part Number	Part Description	Quantity
1	105200482	CONNECTING BAR	2
2	105200483	CART ENCLOSURE	1
3	105200484	CART BACK PANEL	1
4	105200485	DRAWER SLIDING RAIL	2
5	105200122	CART BACK WHEEL	2
6	155200079	CYLINDER RACK	1
7	105200486	CART DRAWER	1
8	105200487	CART BOTTOM	1
9	105200488	ACCESSORIES BIN	1
10	105200128	CASTER WHEEL	2
11	105200489	CART FRONT BEZEL	1
12	105200490	DRAWER SUPPORT BAR	1

For replacement parts please call (888) 762-4045.

METAL MAN[®]

METAL MAN WORK GEAR CO.

1760 Prospect Ct, Suite 120

Appleton, WI 54914

888-762-4045

www.metalmangear.com

Made in China